

COURS DE DESSIN TECHNIQUE
DESSIN & LECTURE DE PLAN
SECTION MECANIQUE POLYVALENTE

Deuxième degré – 3^{ème} année - 20...../20.....

Professeur :
Dominique BONNET

Elève :

.....

LECTURE DE PLAN – PREMIER MODULE

OBJECTIFS

L'élève doit être capable de :

- Reconnaître les éléments de présentation d'un dessin technique
- Reconnaître les principaux traits
- Associer une même surface ou un même volume dans plusieurs vues d'une mise en plan en utilisant les méthodes de correspondances des vues
- Définir la position et le nom des vues principales
- Dessiner une des vues sur base des deux autres

COMPETENCES VISEES :

- | | |
|---|-------------|
| - Reconnaître des tracés géométriques | pg. 3 |
| - Identifier les traits conventionnels | pg. 4 |
| - Retrouver une vue en projection orthogonale | pg. 5 & 6 |
| - Comprendre le mécanisme des trois vues | pg. 7 |
| - Positionner des points sur les trois vues | pg. 8 & 9 |
| - Positionner les différentes vues, les compléter et les coter | pg. 10 |
| - Produire les trois vues cotées d'une pièce | pg. 11 & 12 |
| - Retrouver des points d'une perspective sur les trois vues | pg. 13 |
| - Retrouver les deux vues correspondants aux différentes perspectives | pg. 14 |
| - Dessiner la troisième vue | pg. 15 |
| - Produire les croquis d'une pièce | pg. 16 & 17 |

CAPACITES VISEES : LA LECTURE

SAVOIRS ET SAVOIRS-FAIRE PRE-REQUIS :

- Aucun pré-requis technique n'est nécessaire.

PROJECTIONS ET COTATIONS

Les 3 plans de projections

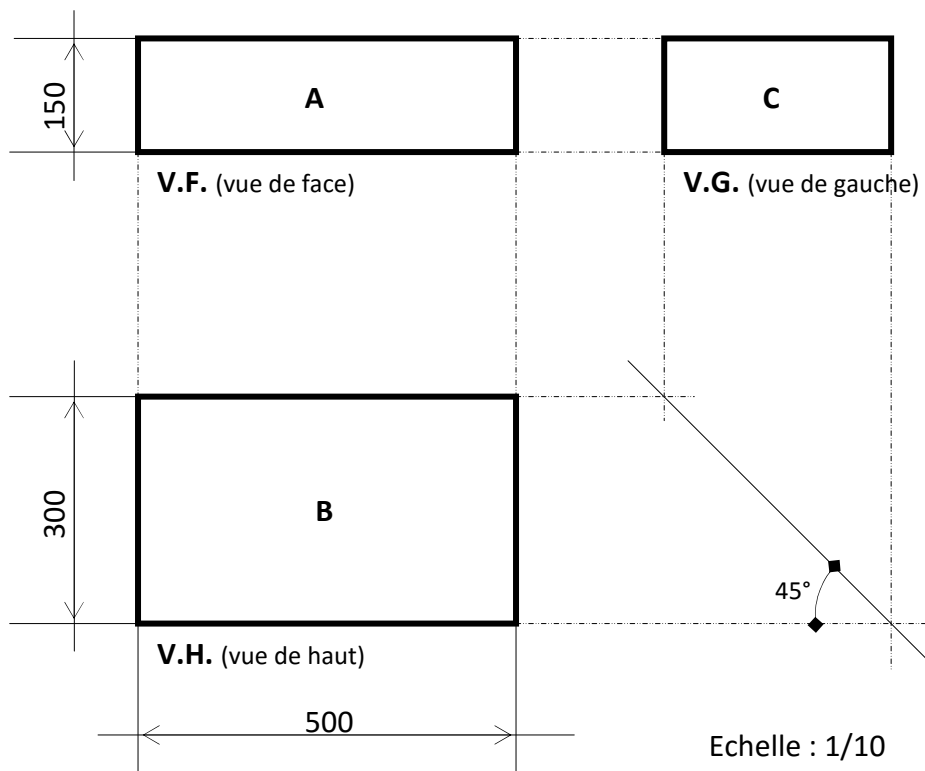
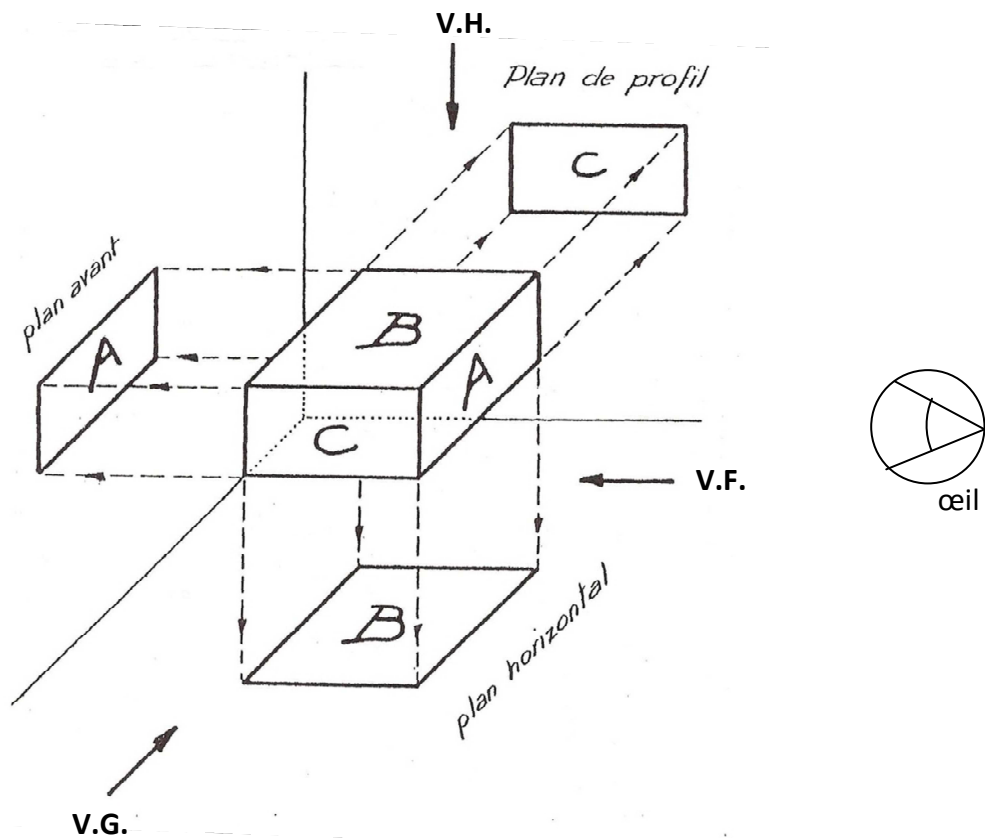

TRACÉS GÉOMÉTRIQUES

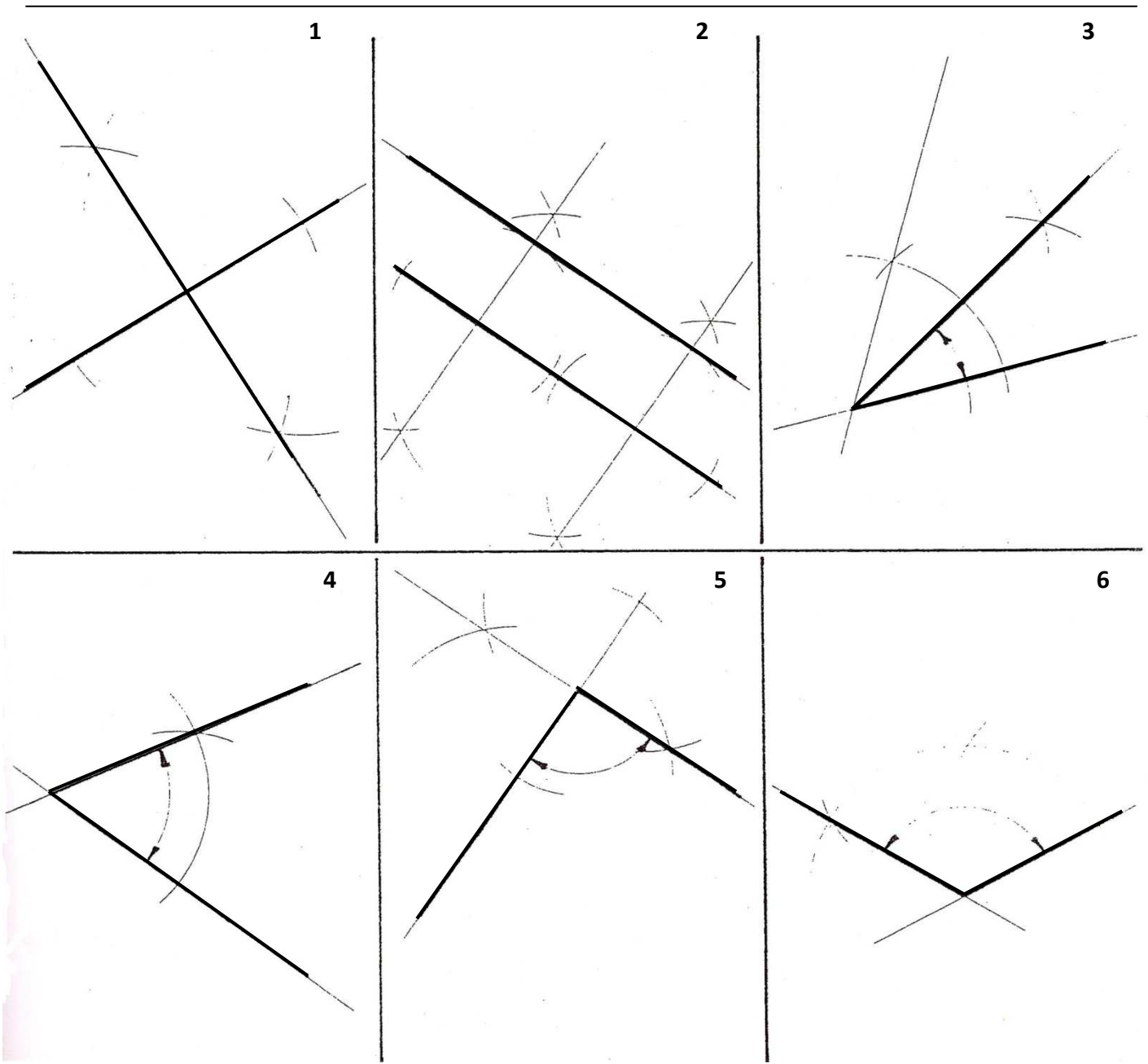

Ces tracés correspondent à six représentations géométriques.

→ Retrouve l'appellation de chaque tracé en inscrivant dans la case le numéro correspondant :

Droites parallèles	2
Droites qui forment un angle de 60°	4
Droites qui forment un angle de 30°	3
Droites perpendiculaires	1
Droites qui forment un angle de 120°	6
Droites qui forment un angle droit	5

TRAITS CONVENTIONNELS

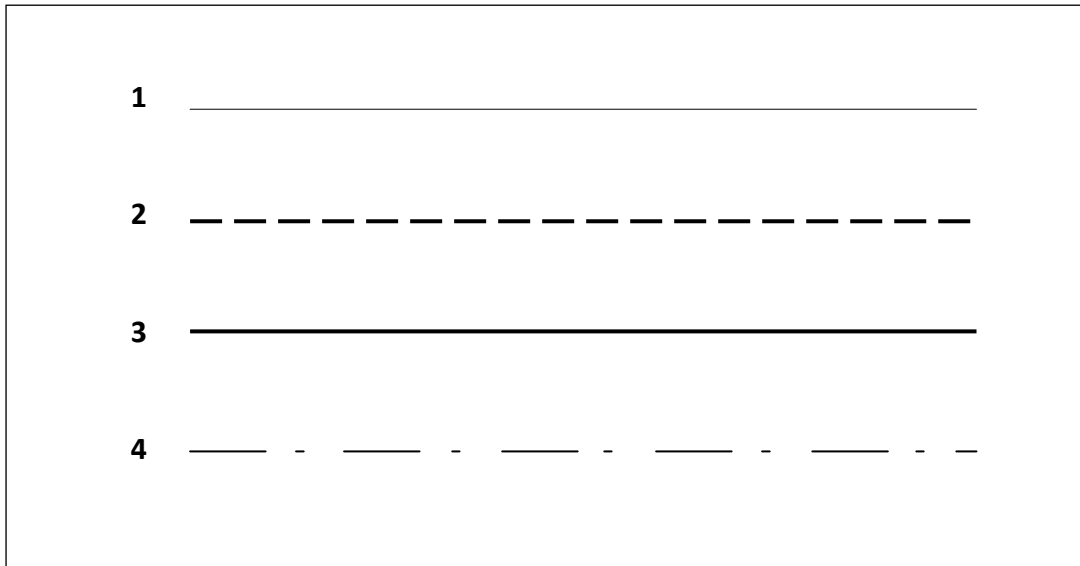

Ces traits représentent les quatre traits conventionnels.

→ Retrouve l'appellation de chaque trait en inscrivant dans la case le numéro correspondant :

Trait fort	3
Trait mixte	4
Trait fin	1
Trait pointillé	2

Quelle est la fonction de ces traits en dessin technique ?

→ Retrouve la fonction du trait en inscrivant dans la case le numéro correspondant :





Contours visibles (arêtes vues)	3
Arêtes cachées	2
Trait de cotation et hachures	1
Trait d'axe	4

VUES



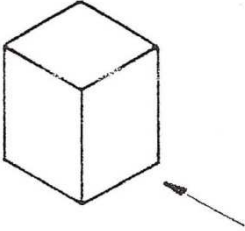
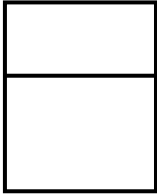

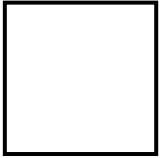
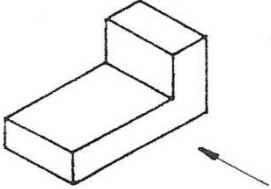
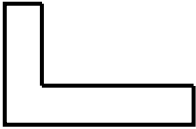
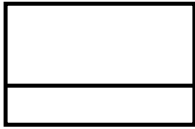
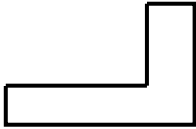
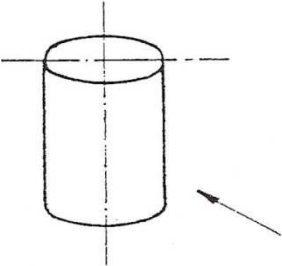
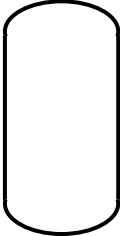
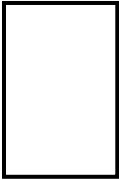
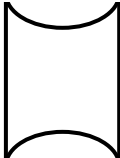
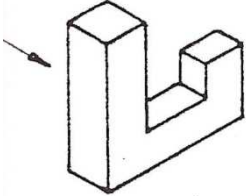
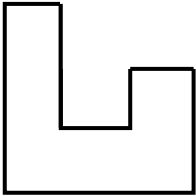
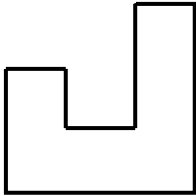
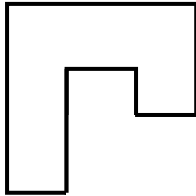
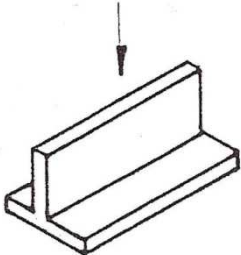
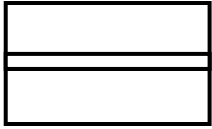

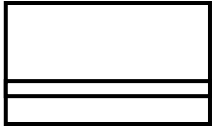
Recherche de la vue indiquée

Une des trois vues représentées à côté de la figure dessinée en perspective correspond à la vue indiquée par la flèche.

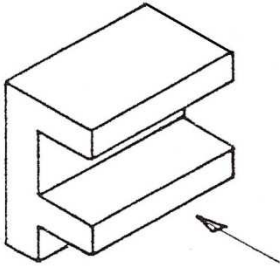
→ Désigne la figure correspondante en traçant une croix dans la petite case inférieure droite.

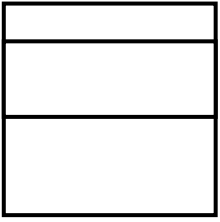
				X
				X
				X
				X
				X

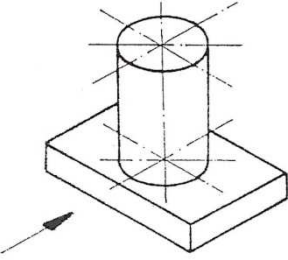
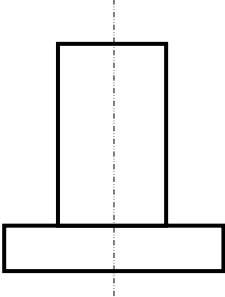
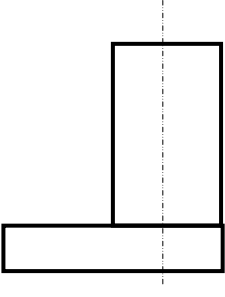
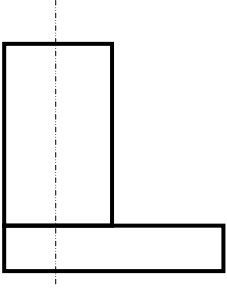
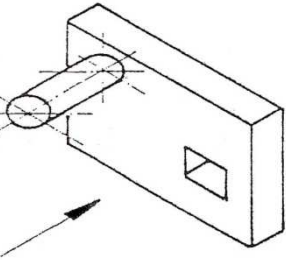
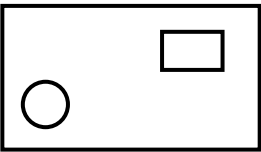
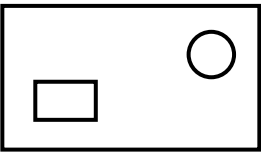
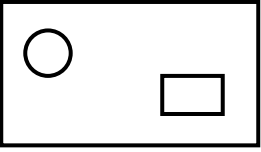
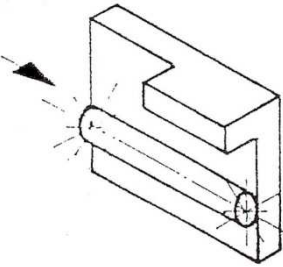
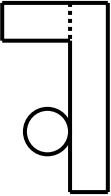
Recherche de la vue indiquée (suite)

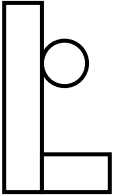
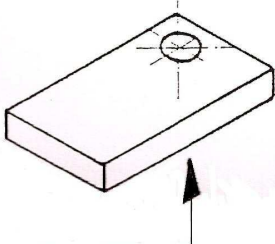
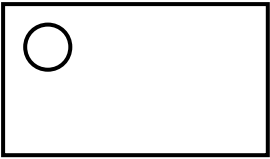
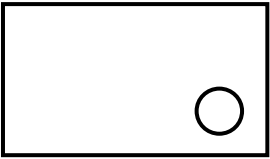
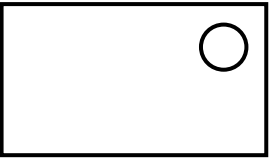
MECANISME DES TROIS VUES

Projection de points

Exemple :

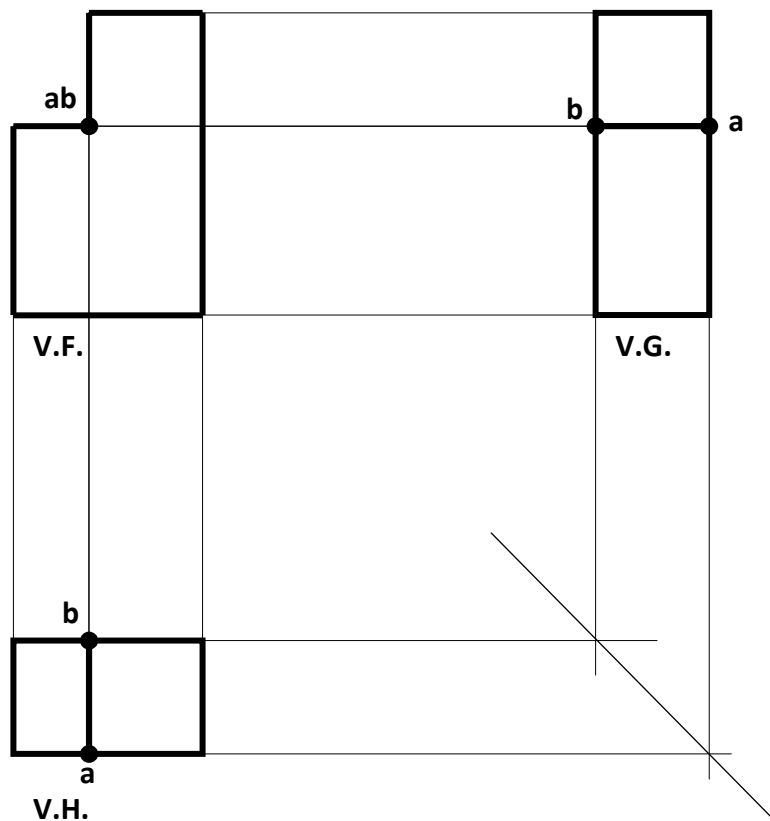
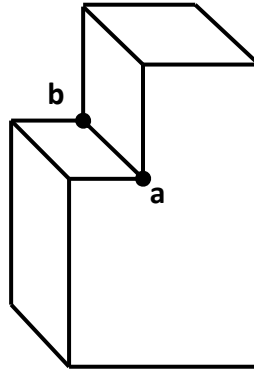

Cette figure en perspective cavalière est représentée par trois vues élémentaires (V.F. – V.H. – V.G)
Si l'on regarde les points « a » et « b » de la figure, on constate qu'il est possible de les indiquer sur les trois vues.

Projection de points (suite)

Exercices :

Positionne les points « a » et « b » sur les trois vues.

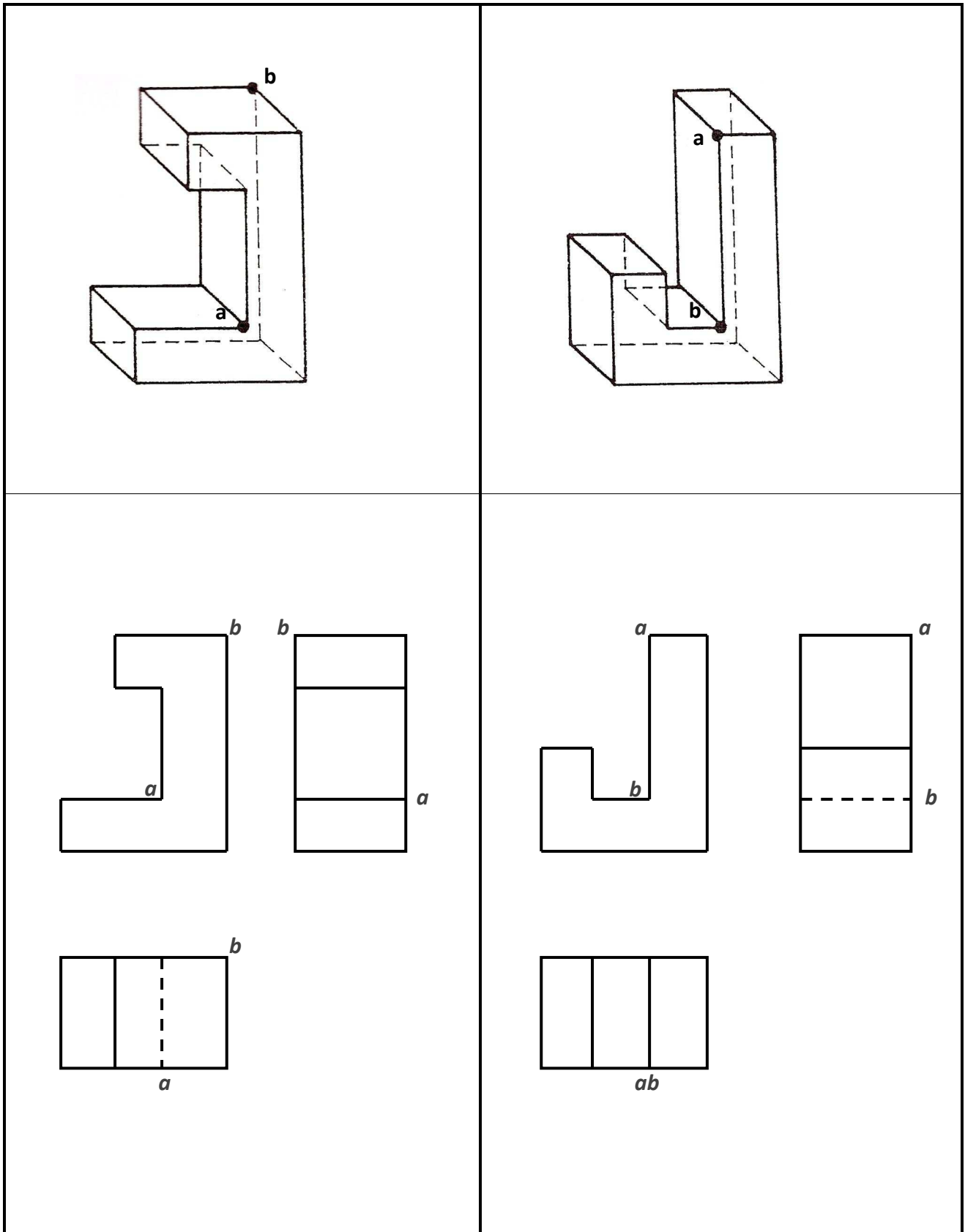

Projection de points (suite)

Positionne les points « *a* » et « *b* » sur les trois vues.

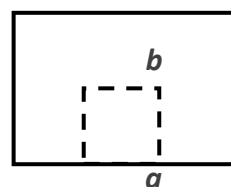
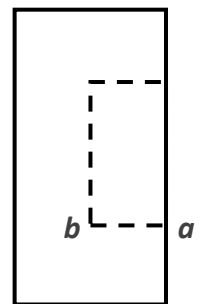
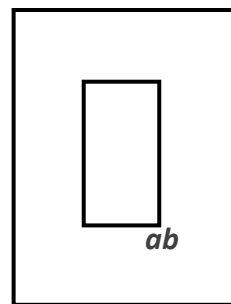
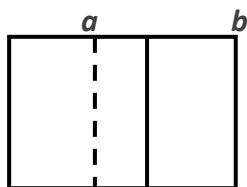
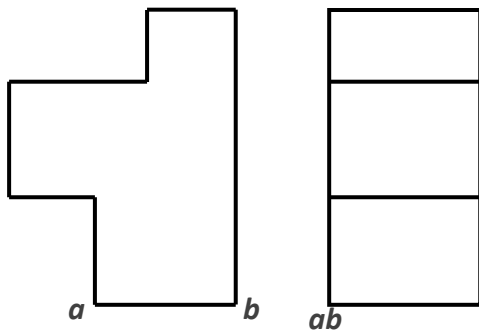
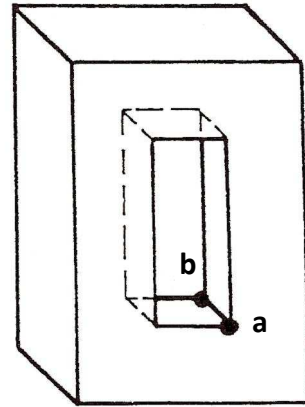
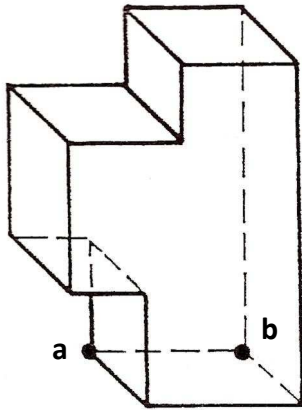

Les trois vues

D'après la perspective cavalière complète les trois vues et indique leur nom.
Cote les vues en vue de l'exécution.

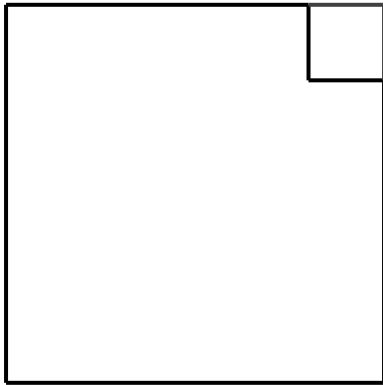

V.F.



V.G.

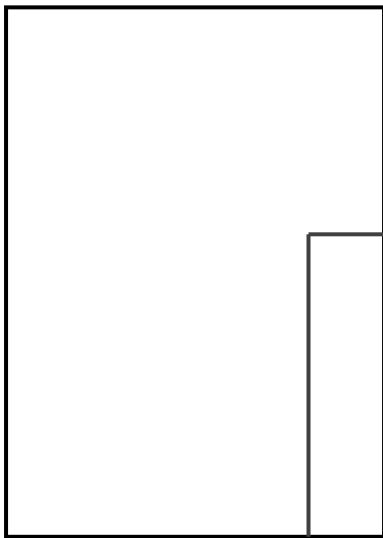

V.H.

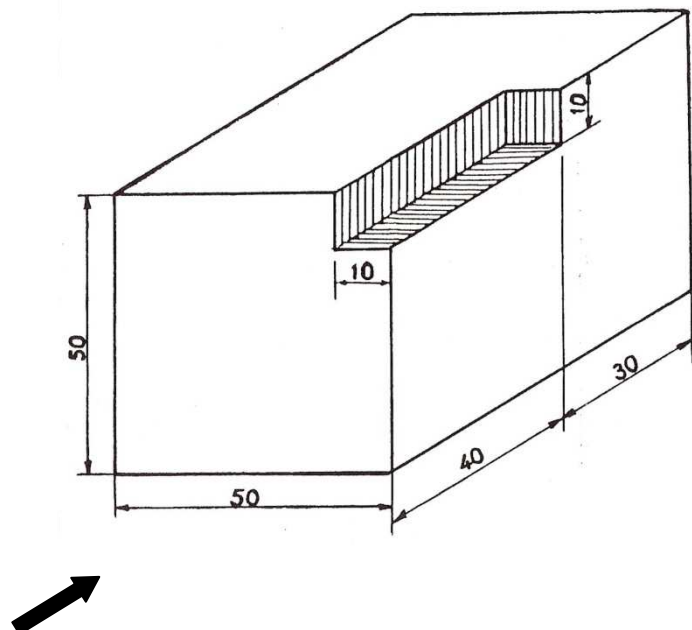

Les trois vues (suite)

D'après la perspective cavalière recherche et dessine la troisième vue.
Indique le nom de chaque vue et cote la vue trouvée en vue de l'exécution.

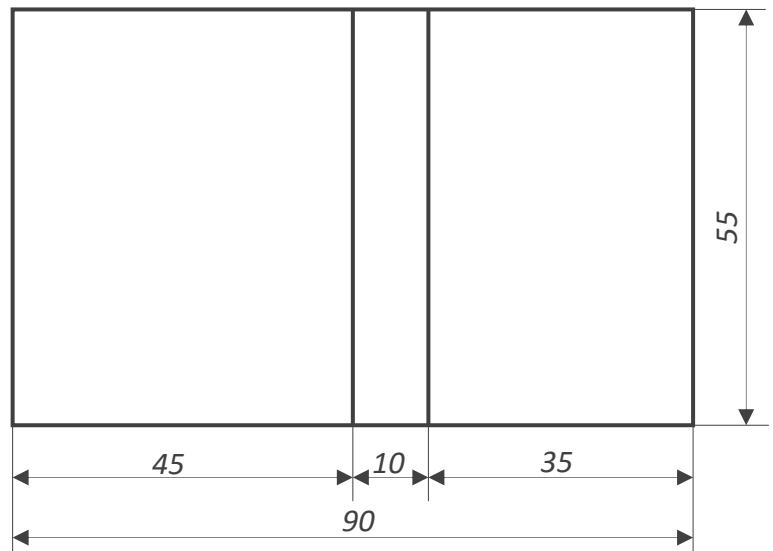
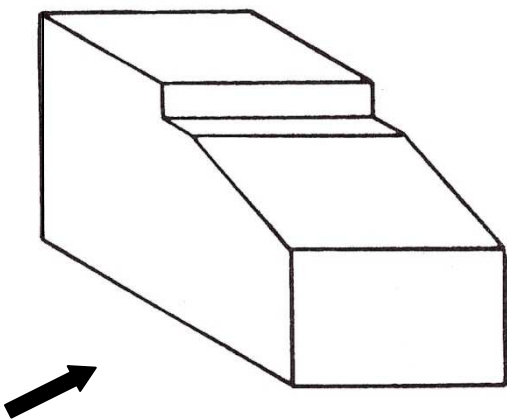
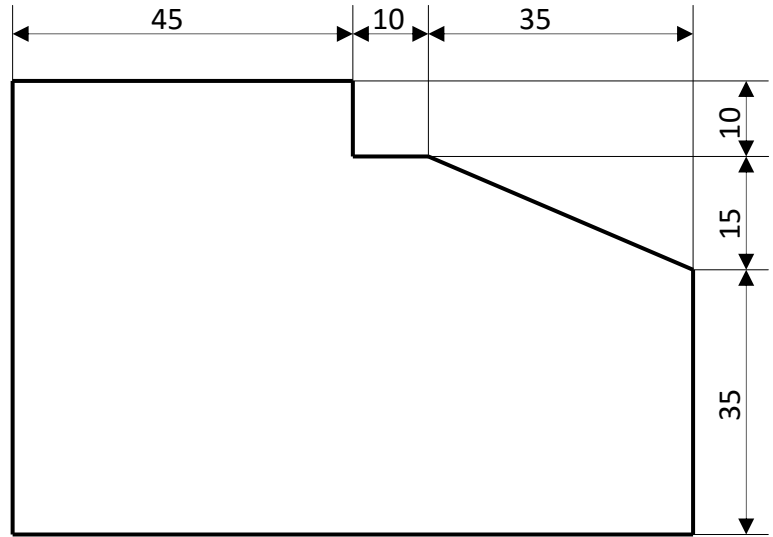
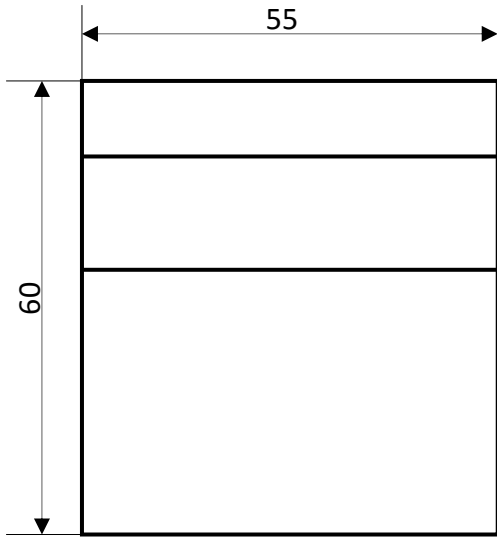

Les trois vues (suite)

Recherche et dessine la troisième vue.

Indique le nom de chaque vue et cote la vue trouvée en vue de l'exécution.

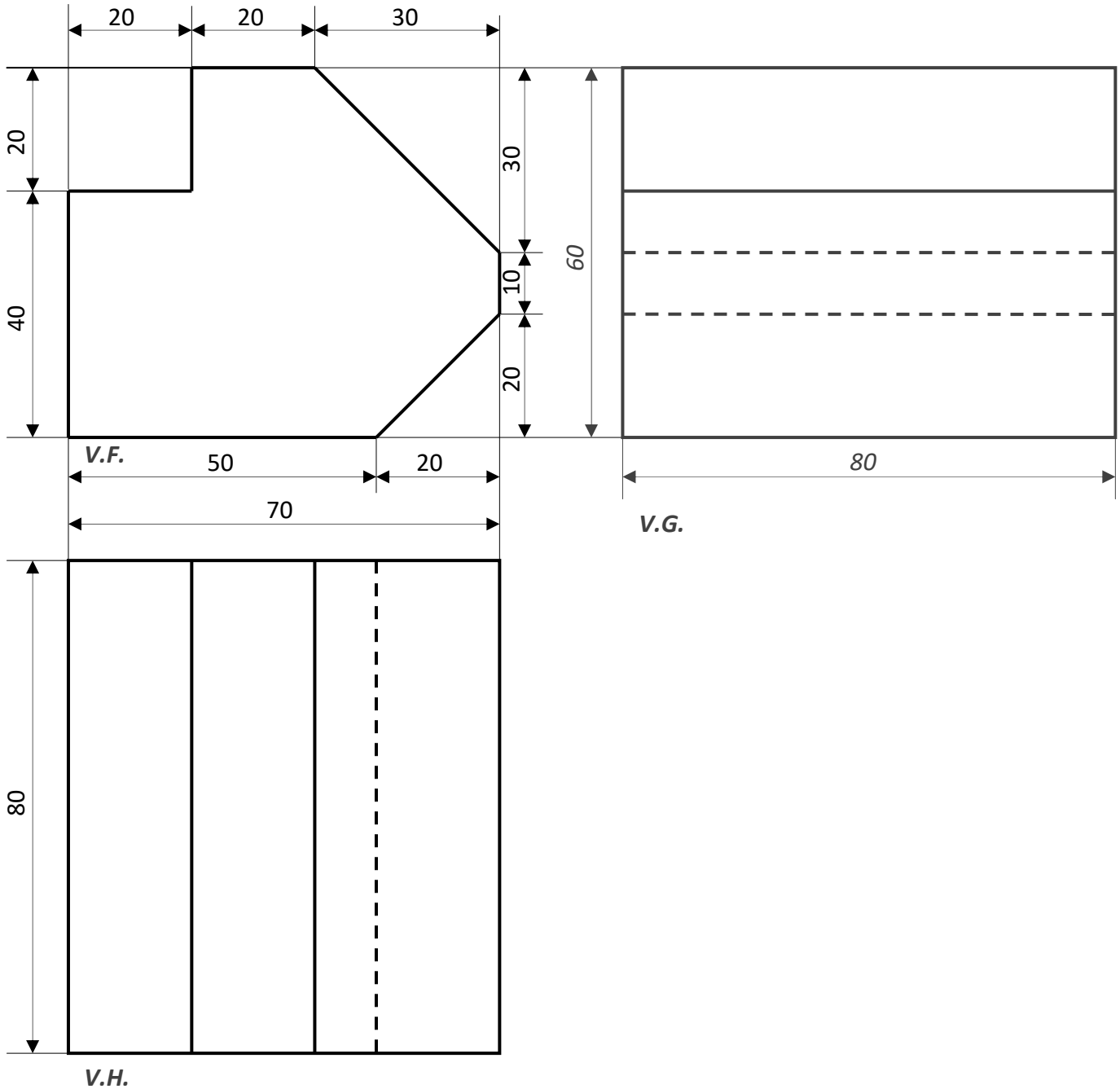

Les trois vues (suite)

Remplace les chiffres de la perspective cavalière dans les trois vues.

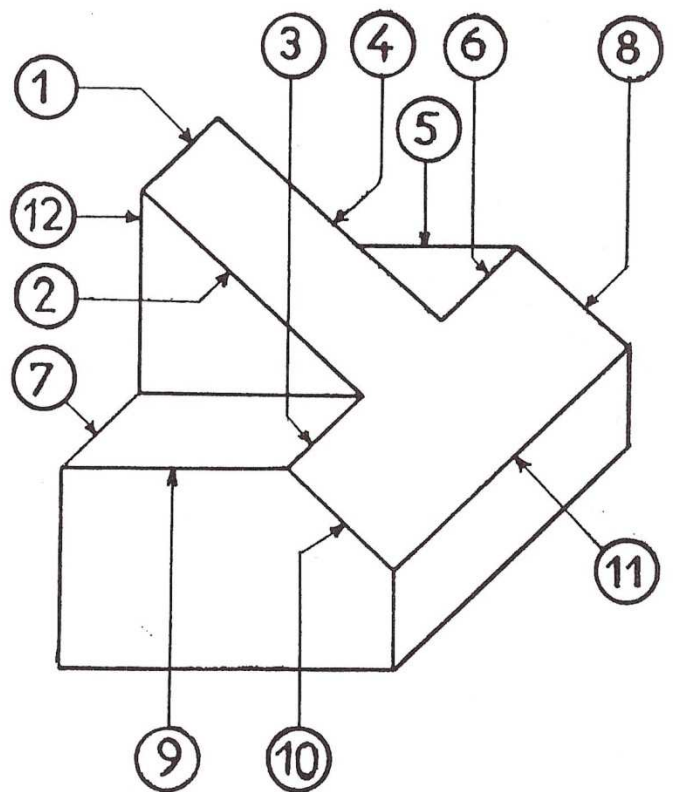
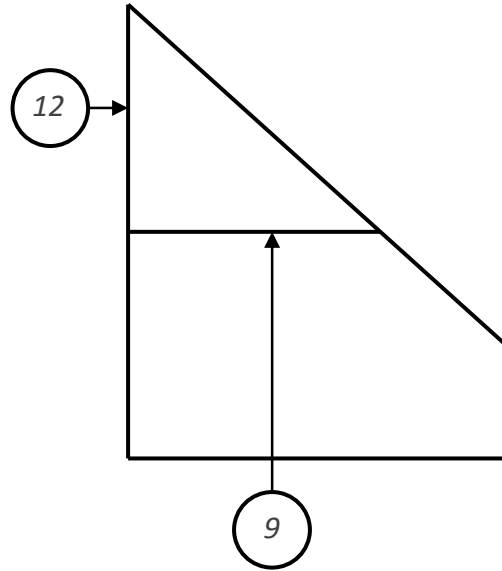
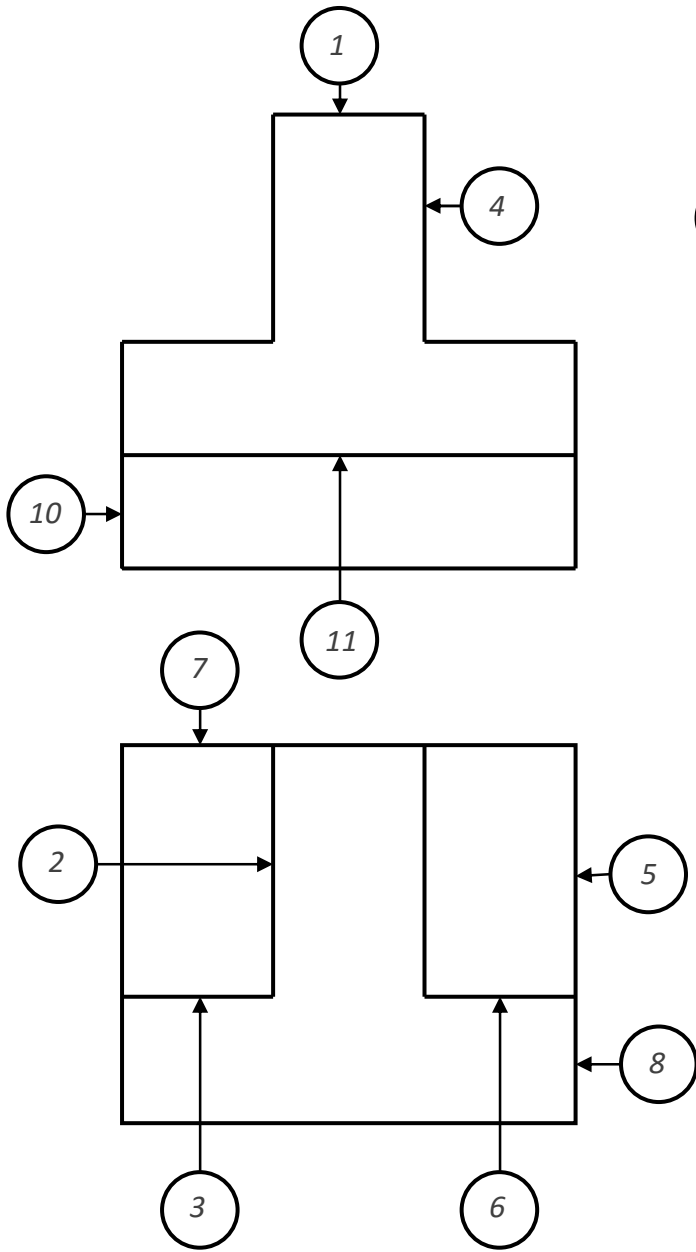

Les trois vues (suite)

Remplace les chiffres de la perspective cavalière dans les trois vues.

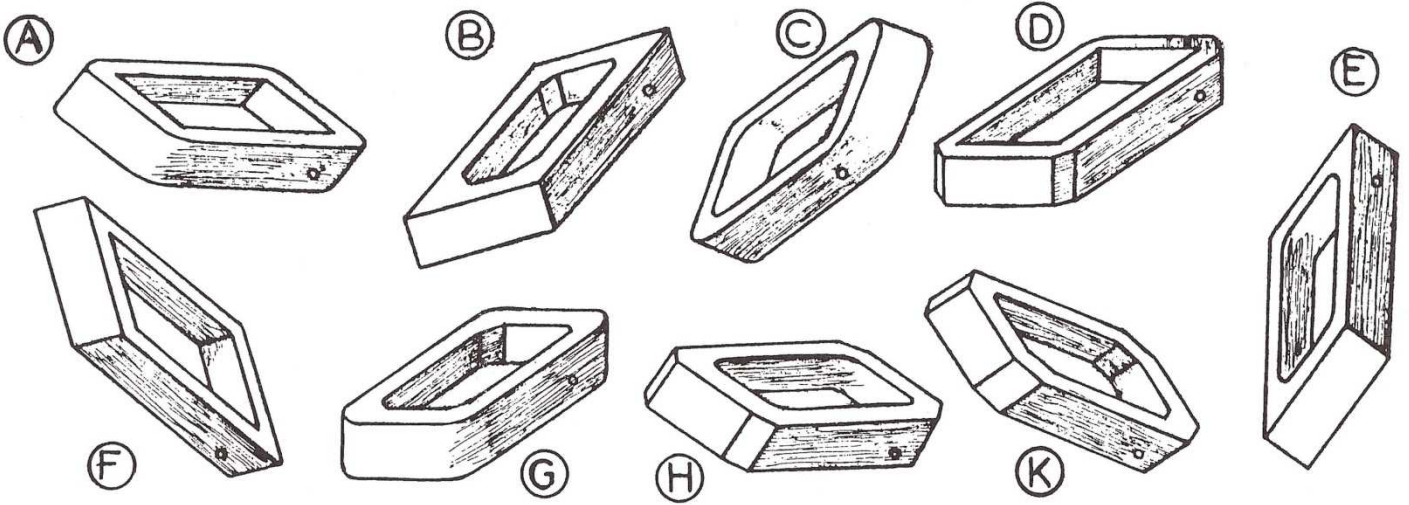

G

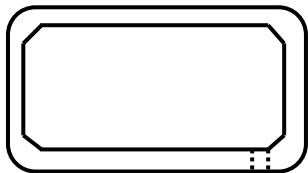

E

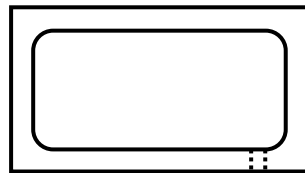

H

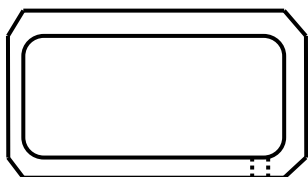

A

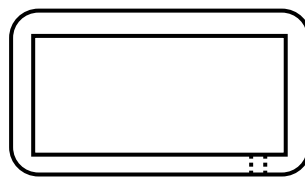

Les trois vues (suite)

Recherche la troisième vue et nomme chaque vue.

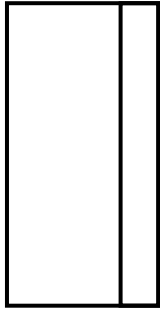

V.F.

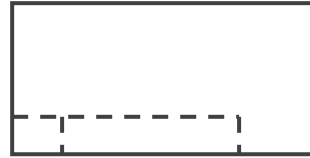
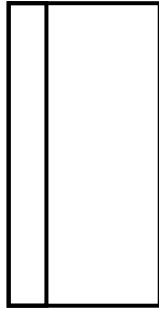

V.F.

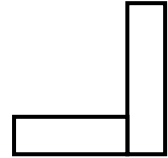

V.G.

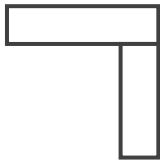

V.H.



V.H.

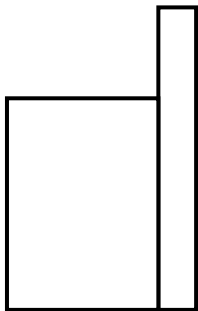

V.F.

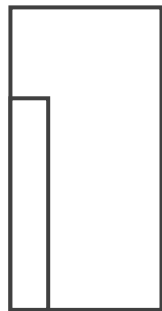

V.G.

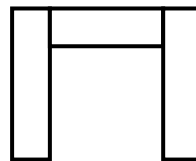

V.B.

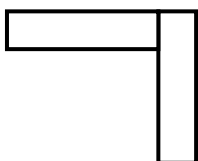

V.H.

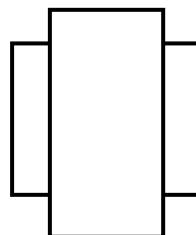

V.F.

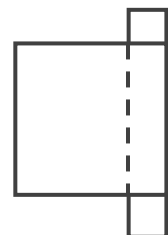

V.G.

PRODUIRE LE CROQUIS D'UNE PIÈCE

Vé de serrage

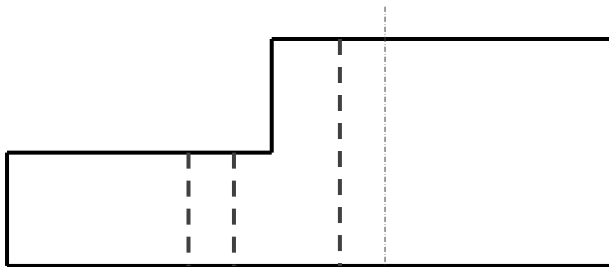

V.F.

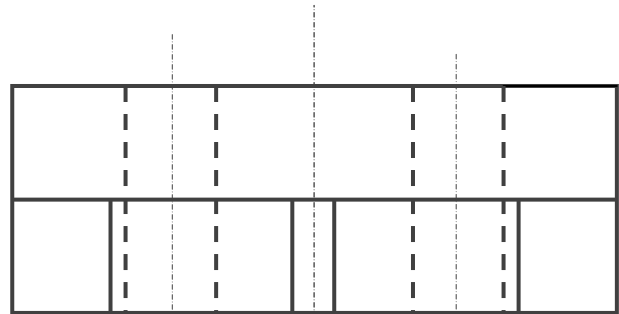

V.G.

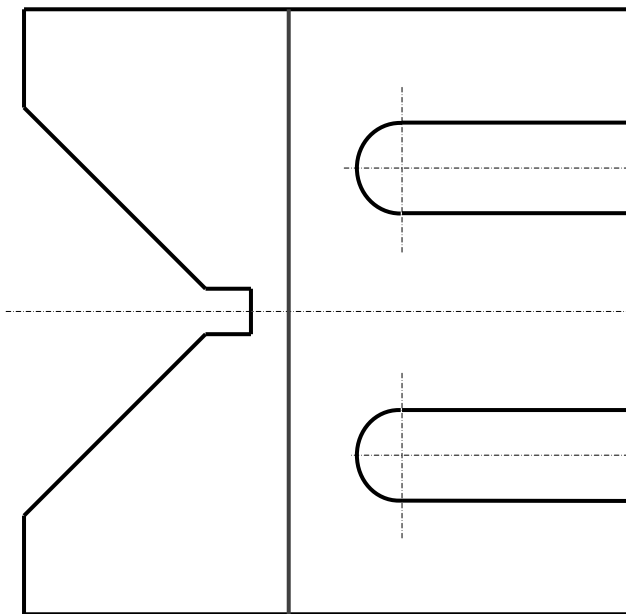

V.H.

Données :

- V.F. et V.H. incomplètes
- Position de V.G.

Exercice :

- Complète V.F. et V.H.
- Dessine V.G.
- Nomme chaque vue

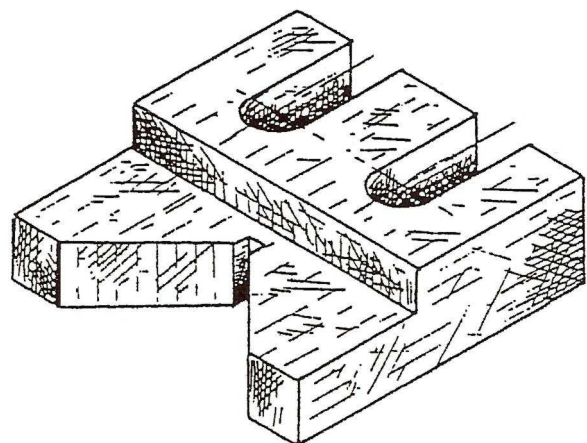

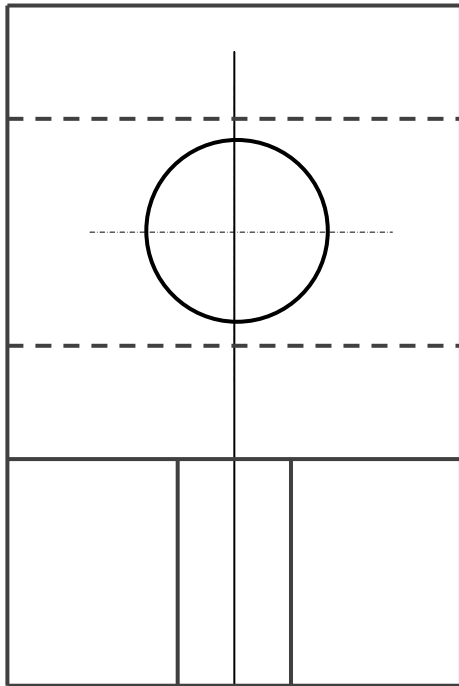
Butée réglable

V.D.

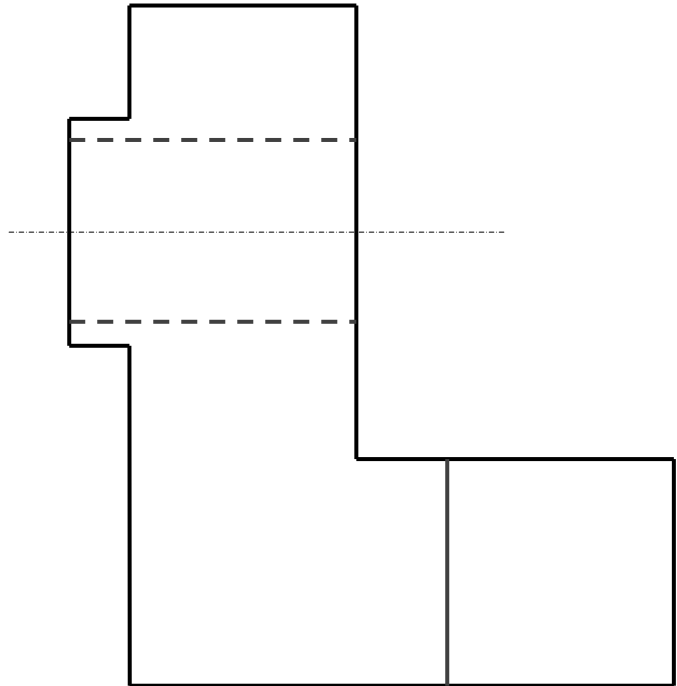

V.F.

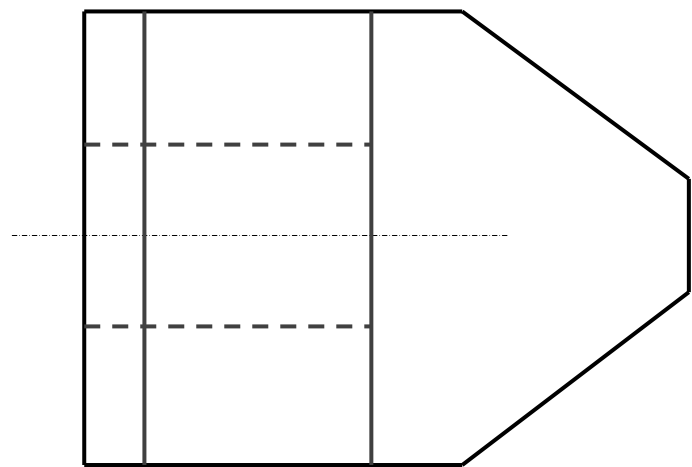

V.H.

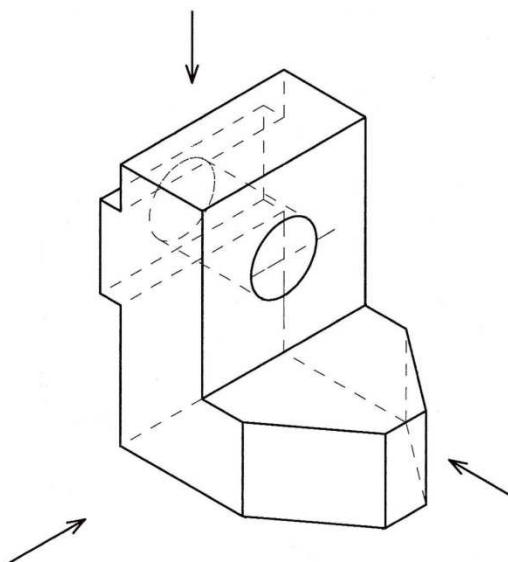

Données :

- V.F. et V.H. incomplètes
- L'amorce de V.D.

Exercice :

- Complète V.F. et V.H.
- Dessine V.D.
- Nomme chaque vue